

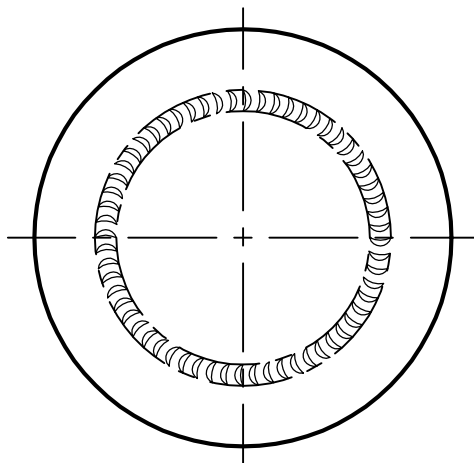

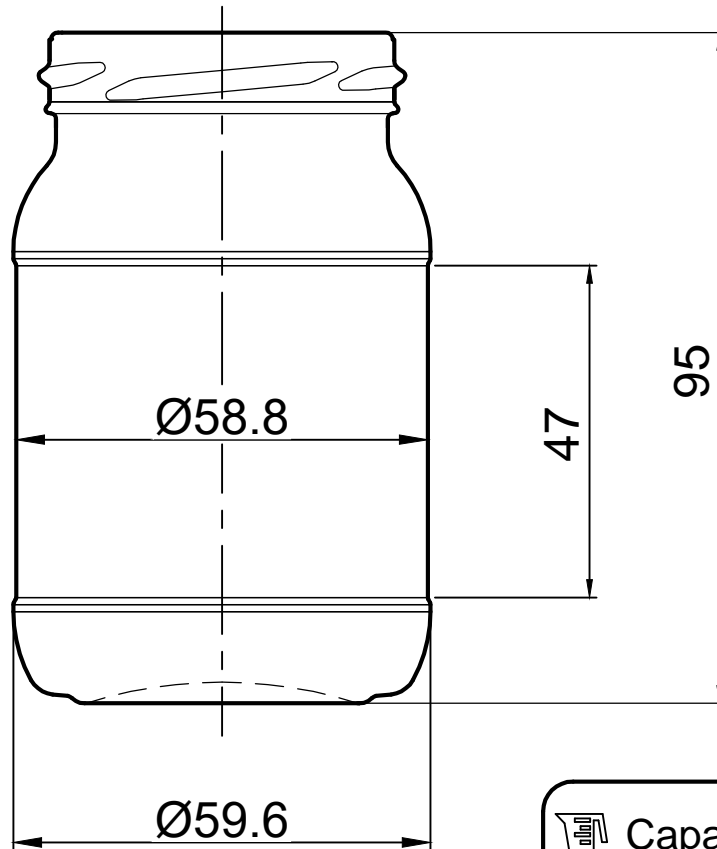





BABY FOOD 170ML

3.71-III-3-53-170



-  Capacity: **170ml**
-  Weight: **107g**
-  Height: **95mm**
-  Diameter: **59.6mm**
-  Finish: **TO-53**
-  Pallet: **1200x800x2020mm**
-  Quantity: **5567pcs**
-  Weight of: **621kg**
pallet